

A

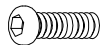

x4

B



x4

## ASSEMBLY INSTRUCTIONS

COUNTER STOOL MODEL#: FYC297

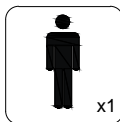
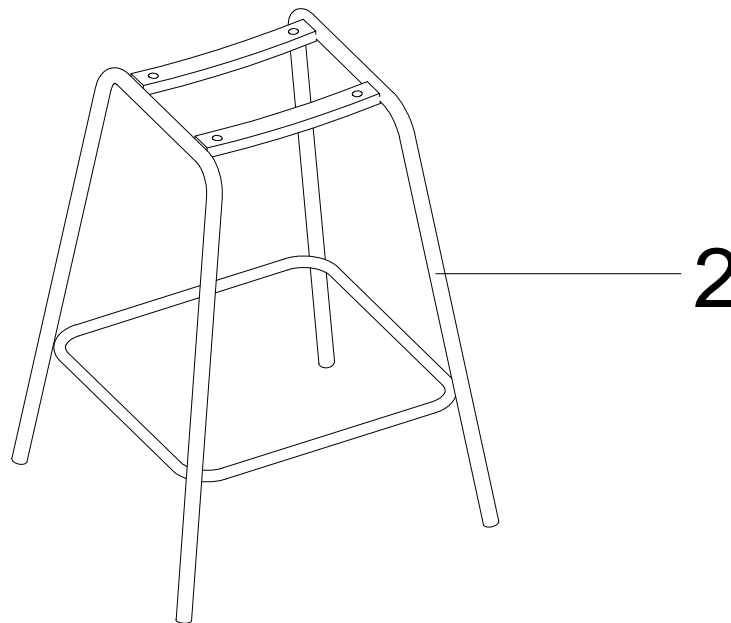
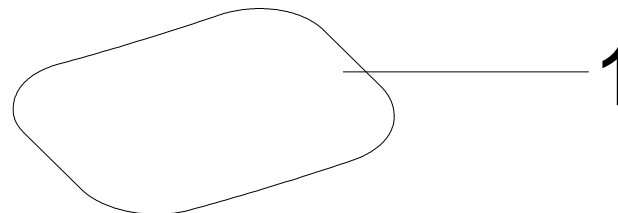
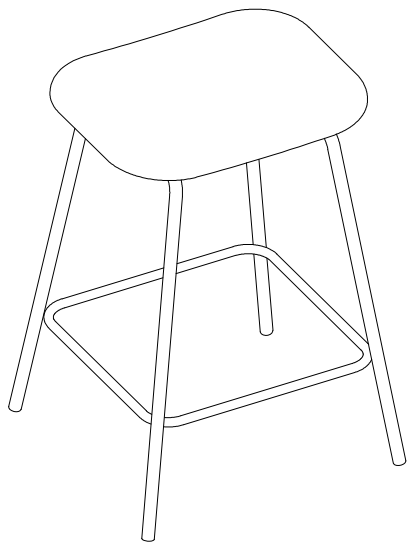

x1

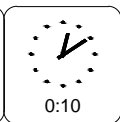

0:10

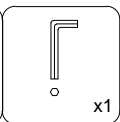

x1

# Step: 1

